

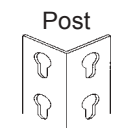

# SERIES 200B ASSEMBLY INSTRUCTIONS

SAMPLE MODEL NUMBER CODE	
	BH3-9624-84WHCR
Series 200B _____	_____
Heavy Duty Shelving (11 Gauge) _____	_____
Number of Shelves _____	_____
Shelf Width in Inches _____	_____
Shelf Depth in Inches _____	_____
Unit Height in Inches _____	_____
Particle Board Decking Included _____	_____
Shelf Deck Support (1 per shelf) _____	_____
Channel Beam _____	_____
Heavy Duty Channel Beam _____	_____

COMPONENT DESCRIPTIONS	
 <p>Post</p>	 <p>Shelf Deck Support</p>
 <p>Double Rivet Beam</p>	 <p>Double Rivet Channel Beam OR Heavy Duty Double Rivet Channel Beam</p>

## STEP 1: Bottom Shelf

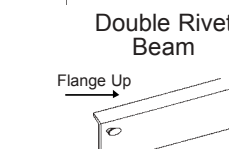
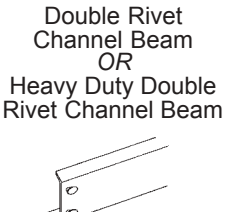
1. Components: 4 Posts (P)
  - 2 Double Rivet Beams (DR)
 

These are the steel beams that support the front and back of the shelf.
  - 2 Double Rivet Beams (DR)
 

These are the steel beams that support the sides of the shelf.
  - 1 Shelf Deck Support (SDS), if applicable.
 

These are the steel supports that support the center of the decking. Units with deck supports are standard 1 per shelf.
2. Build the bottom shelf by inserting the Double Rivet Beams (flange up, see drawing top right ) into the bottom two keyholes of each post. Bolt the Shelf Deck Support from front to back in center of shelf.

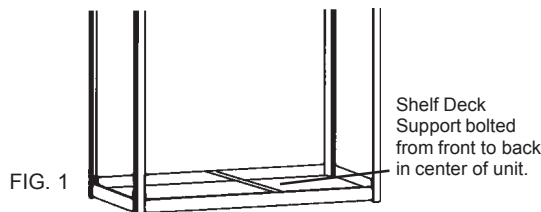

## STEP 2: Top Shelf

1. Components: 2 Double Rivet Beams (DR)
  - These are steel beams that support the front & back of the shelf.
  - 2 Double Rivet Beams (DR)
    - These are the steel beams that support the sides of the shelf.
2. Build the top shelf by inserting the Double Rivet Beams (flange up) into the top two keyholes of each post. Bolt the Shelf Deck Support from front to back in center of shelf (if applicable).

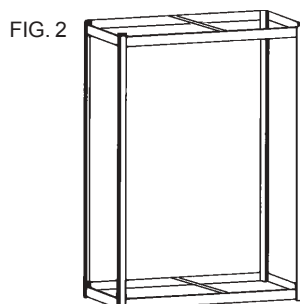

## STEP 3A: Middle Shelves (Standard Capacity)

1. Components: 2 Double Rivet Beams (DR)
  - These are steel beams that support the front and back of the shelf.
  - 2 Double Rivet Beams (DR)
    - These are the steel beams that support the sides of the shelf.
  - 1 Shelf Deck Support (SDS)
    - These are the steel supports that support the center of the decking.
2. Determine the shelf spacing. Insert each Double Rivet Beam into keyhole (flange up) for both front/back and side supports. Bolt 1 Shelf Deck Support from front to back in the center of unit (if applicable). See Figure 3.

**OR**

## STEP 3B: Middle Shelves (Heavy Duty Capacity)

1. Components: 2 Double Rivet Channel Beams (DC)
  - These are the steel beams that support the front and back of the shelf.
  - 2 Double Rivet Heavy Duty Channel Beams (DCH)
    - These are the steel beams that support the front and back of the shelf.
2. Determine the spacing. Insert each Double Rivet Channel or Heavy Duty Channel Beam, Front & Back Supports, into keyholes. Insert each Double Rivet Beam side supports into keyholes (flange up). Bolt 1 Shelf Deck Support from front to back in center of unit. See figure 3.

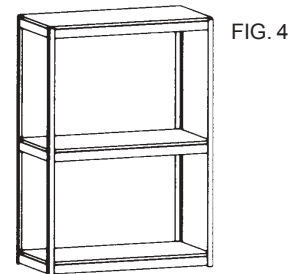
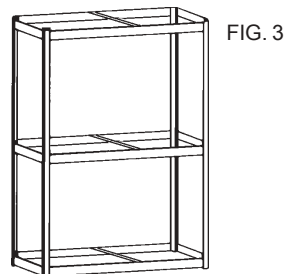

## STEP 4: Particle Board Decking

1. Place one particle board decking on each shelf.

### Special Notes:

1. It is recommended that a rubber mallet be used to hammer the beam securely into place.
2. Cardboard or carpet can be used to protect flooring.